

BATTERIE E PORTABATTERIE

BATTERY AND BATTERY HOLDERS | PILES ET PORTE-PILES



PARTNERS



BATTERIE
Battery
Piles

pag. 92-93



INDICE Index | Index

BATTERIE ALKALINE-MANGANESE

 Alkaline - manganese batteries | *Piles alcalines - manganèse*

BATTERIE AL LITIO

 Lithium batteries | *Piles au lithium*

BATTERIE SPECIALI

 Special batteries | *Piles spéciales*

PORTABATTERIE DA CIRCUITO STAMPATO

 Battery holders for printed circuit | *Supports de piles pour circuit imprimé*

PORTABATTERIE DA PANNELLO A VITE

 Battery holders screw fixing panel mounting | *Porte-piles à vis pour montage sur panneau*

PORTABATTERIE DA PANNELLO A GHIERA

 Battery holders screw on cap panel mounting | *Porte-piles pour panneau avec culot à vis*

PORTABATTERIE IMPERMEABILI IP67

 Battery holders sealing IP67 | *Porte-piles étanches IP67*

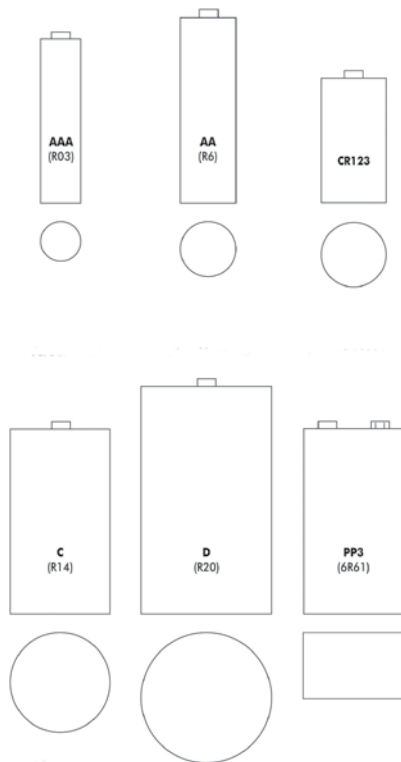
TIPO BATTERIA Battery type | *Type de piles*

VANTAGGI Advantages | *Avantages*

- **Pronta consegna**
Prompt delivery | *Livraison sur stock*
- **Ampia gamma**
Wide range | *Large gamme*

APPLICAZIONI Applications | *Applications*

- **Strumentazione portatile**
Portable equipment
Instruments portatifs
- **Elettromedicali**
Medical equipments
Equipements médicaux
- **Cucine a gas**
Gas stove
Cuisinières à gaz
- **Strumenti musicali giocattolo**
Musical instrument toys
Instruments musicaux jouets

BATTERIE E PORTABATTERIE

Battery and battery holders | Piles et porte-piles



BATTERIE ALKALINE-MANGANESE 1,5V

Alkaline-Manganese 1,5V battery | Piles alcalines - manganèse 1,5V

Tensione 1,5Vdc	Voltage 1,5Vdc	Tension 1,5Vdc
Temperatura d'esercizio -20°C - 54°C	Operating temperature -20°C - 54°C	Température d'utilisation -20°C - 54°C
Temperatura di stoccaggio 5°C - 30°C	Storage temperature 5°C - 30°C	Température de stockage 5°C - 30°C

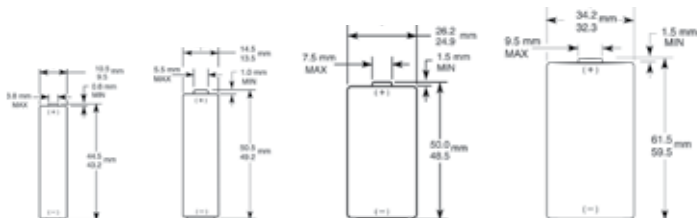

Codice Code Code	ANSI ANSI ANSI	IEC IEC IEC	Ø Ø Ø	Peso Weight Poids	
BXBLR03	AAA	LR03	9,5/10,5	11g	10
BXBLR6	AA	LR6	13,5/14,5	24g	10
BXBLR14	C	LR14	24,9/26,2	69g	10
BXBLR20	D	LR20	32,3/34,2	139g	10

Dimensioni | Dimensions | Dimensions

AAA - LR03

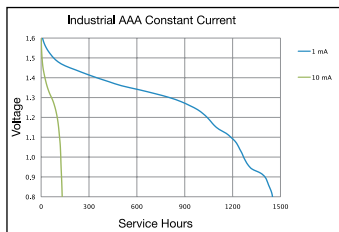

AA - LR6

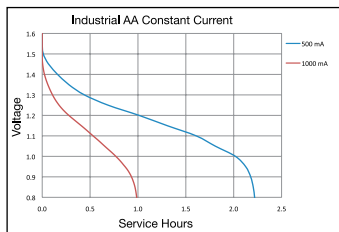

C - LR14

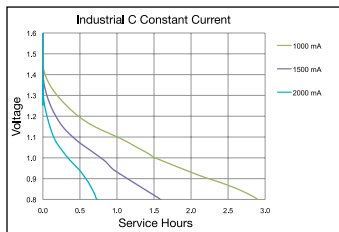

D - LR20

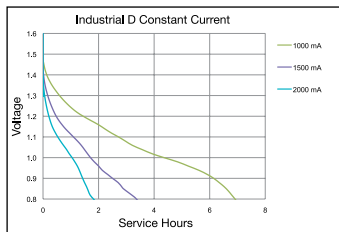

BATTERIE ALKALINE-MANGANESE 9V

Alkaline-Manganese 9V battery | Piles alcalines - manganèse 1,5V

Tensione 9Vdc	Voltage 9Vdc	Tension 9Vdc
Temperatura d'esercizio -20°C to 54°C	Operating temperature -20°C to 54°C	Température d'utilisation -20°C to 54°C
Temperatura di stoccaggio 5°C - 30°C	Storage temperature 5°C - 30°C	Température de stockage 5°C - 30°C

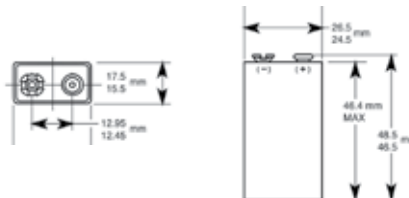

Codice Code Code	ANSI ANSI ANSI	IEC IEC IEC	Peso Weight Poids	
BXB6LR61	9V	6LF22	45g	10

Dimensioni | Dimensions | Dimensions

Industrial 9V Constant Current

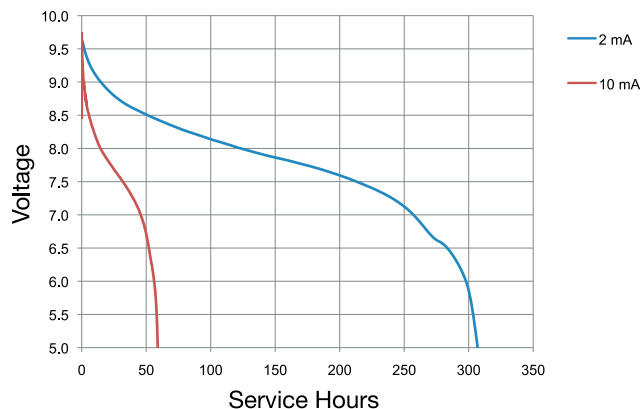

BATTERIE E PORTABATTERIE

Battery and battery holders | Piles et porte-piles



BATTERIE AL LITIO 3V

Lithium 3V battery | Piles au lithium 3V

Tensione	Voltage	Tension
3Vdc	3Vdc	3Vdc
Temperatura d'esercizio	Operating temperature	Température d'utilisation
-20°C +54°C (CR2032)	-20°C +54°C (CR2032)	-20°C +54°C (CR2032)
-20°C +75°C (Ultra123)	-20°C +75°C (Ultra123)	-20°C +75°C (Ultra123)

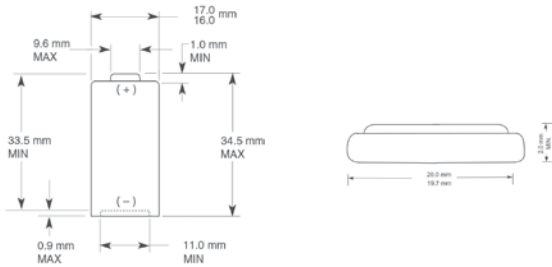

Codice	ANSI	IEC	Ø	Peso	
Code	ANSI	IEC	Ø	Weight	
Code	ANSI	IEC	Ø	Poids	
BXBCR17345	5018LC	CR17345	16/17	17,0g	1200
BXBCR2032	5004LC	CR2032	19,7/20	3,14g	400

Dimensioni | Dimensions | Dimensions

5018LC - CR17345

Delivered Energy vs. Power Drain
 @ Various Cutoff Voltage - Room Temperature

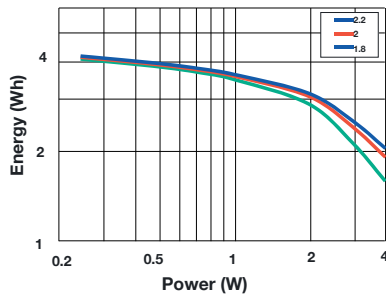

5004LC - CR2032

Typical Discharge Characteristics at 21°C (70°F)

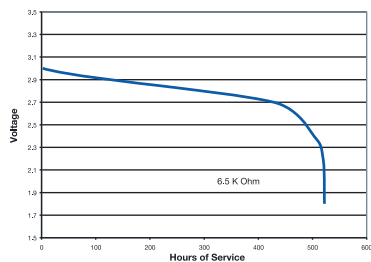

BATTERIE SPECIALI ALCALINE

Alkaline special battery | Piles spéciales alcalines

Tensione	Voltage	Tension
12Vdc	12Vdc	12Vdc
Temperatura d'esercizio	Operating temperature	Température d'utilisation
-20°C +54°C	-20°C +54°C	-20°C +54°C

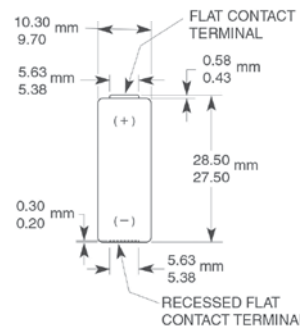

Codice	NEDA	Ø	Peso	
Code	NEDA	Ø	Weight	
Code	NEDA	Ø	Poids	
BXBMN21	1811A	9,7/10,3	7,4g	10

Dimensioni | Dimensions | Dimensions

TYPICAL DISCHARGE CHARACTERISTICS AT 21°C (70°F)

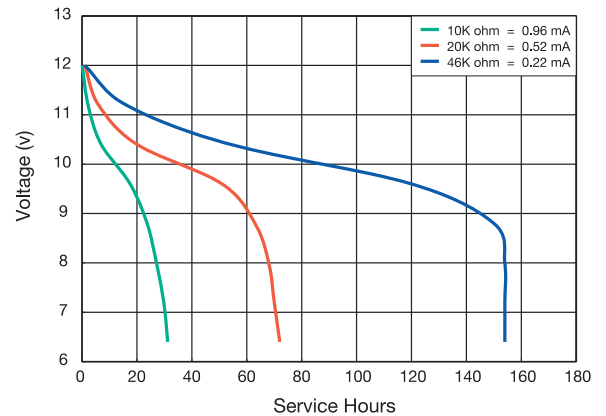

BATTERIE E PORTABATTERIE

Battery and battery holders | Piles et porte-piles

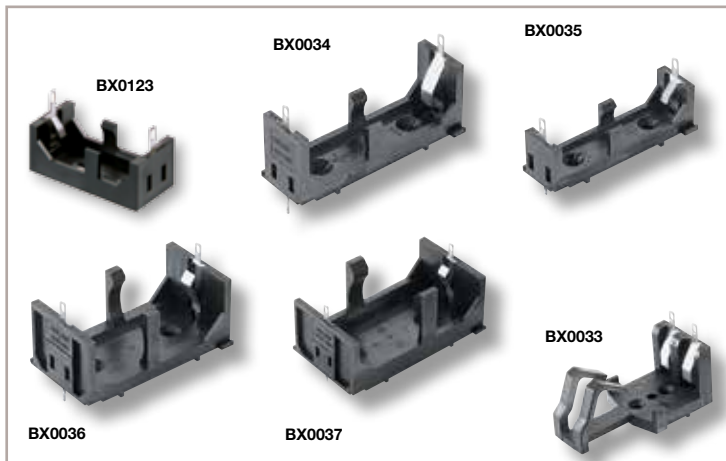

PORTABATTERIE PER CIRCUITO STAMPATO

Battery holders for printed circuit | Supports de piles pour circuit imprimé

Corpo	Body	Corps
Nylon caricato vetro UL94V-0	Glass filled nylon UL94V-0	Nylon chargé verre UL94V-0
Contatti Argento nichelato	Contacts Nickel plated silver	Contacts Argent nickelé
Temperatura di lavoro -30°C +70°C	Operating temperature -30°C +70°C	Température de travail -30°C +70°C



Codice	Tipo batteria	Dimensioni batteria	N°poli
Code	Battery type	Battery dimension	N°poles
Code	Type de pile	Dimension de pile	N°pôles
BX0123	CR123	Ø17x34,5	1
BX0034	AAA (R03)	Ø10,5x44,5	1
BX0035	AA (R6)	Ø14,5x50,5	1
BX0036	C (R14)	Ø26,2x50	1
BX0037	D (R20)	Ø34,2x61,5	1
BX0033	PP3 (6R61)	L 26,5 X P 17,5 X H 48,5	1

Dimensioni | Dimensions | Dimensions

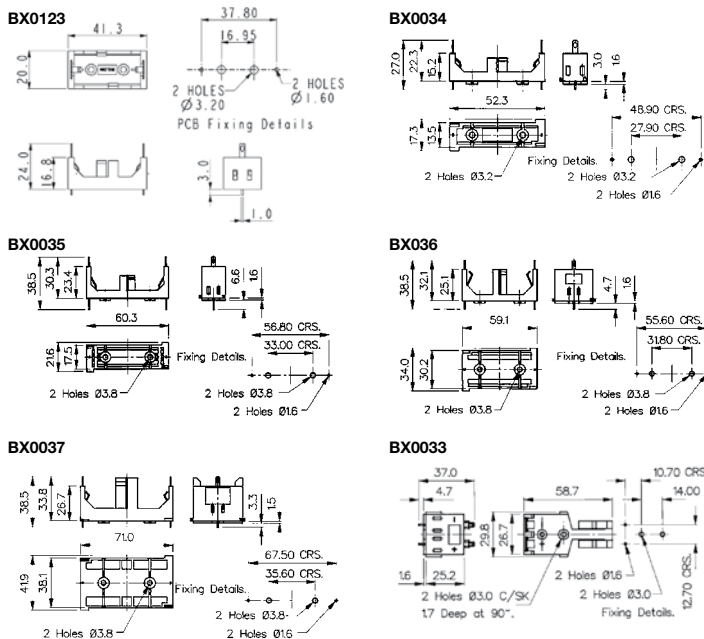

1 pz
 1 pc
 1 pce
 pronta in stock
 en stock

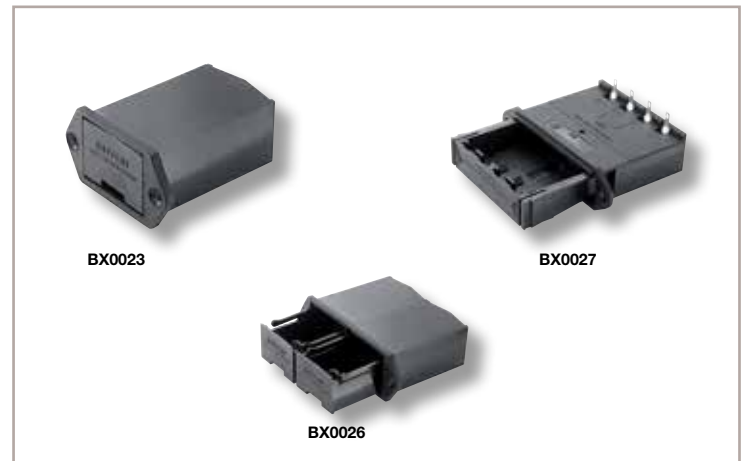

PORTABATTERIE DA PANNELLO

Battery holders panel mounting | Supports de piles pour panneau

Corpo	Body	Corps
Nylon caricato vetro UL94V-0	Glass filled nylon UL94V-0	Nylon chargé verre UL94V-0
Contatti A saldare 2,8 bronzo stagnato	Contacts 2,8 solder tinned bronze	Contacts À souder 2,8 bronzo étamé
Temperatura di lavoro -30°C +70°C	Operating temperature -30°C +70°C	Température de travail -30°C +70°C



Codice	Tipo batteria	Dimensioni batteria	N°poli
Code	Battery type	Battery dimension	N°poles
Code	Type de pile	Dimension de pile	N°pôles
BX0023	PP3 (6R61)	L26,5 x P17,5 x H48,5	1
BX0026	PP3 (6R61)	L26,5 x P17,5 x H48,5	2
BX0027	AA (R6)	Ø14,5 x 50,5	4

Dimensioni | Dimensions | Dimensions

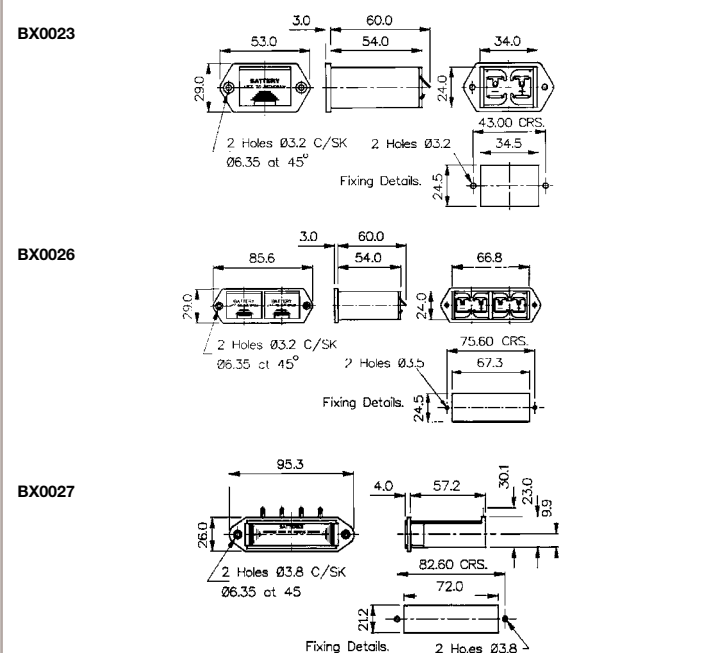

1 pz
 1 pc
 1 pce
 pronta in stock
 en stock

BATTERIE E PORTABATTERIE

Battery and battery holders | Piles et porte-piles



PORTABATTERIE

Battery holders | Porte-piles

Corpo	Body	Corps
Nylon caricato vetro UL94V-0	Glass filled nylon UL94V-0	Nylon chargé verre UL94V-0
Contatti	Contacts	Contacts
A saldare 2,8 bronzo stagnato Ottone nichelato (BX0016-17-18)	2,8 solder tinned bronze Nickel plated brass (BX0016-17-18)	À souder 2,8 bronze étamé Laiton nickelé (BX0016-17-18)
Temperatura di lavoro -30°C +70°C	Operating temperature -30°C +70°C	Température de travail -30°C +70°C



Codice	Tipo batteria	Dimensioni batteria	N°poli
Code	Battery type	Battery dimension	N°poles
Code	Type de pile	Dimension de pile	N°pôles
BX0001	C (R14)	Ø26,2x50	1
BX0002	C (R14)	Ø26,2x50	2
BX0003	C (R14)	Ø26,2x50	3
BX0011	AA (R6)	Ø14,5x50,5	1
BX0012	AA (R6)	Ø14,5x50,5	2
BX0013	AA (R6)	Ø14,5x50,5	3
BX0016	D (R20)	Ø14,5x50,5	1
BX0017	D (R20)	Ø14,5x50,5	2
BX0018	D (R20)	Ø14,5x50,5	3

Dimensioni | Dimensions | Dimensions

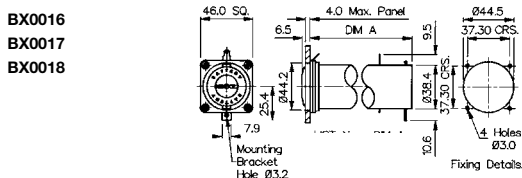
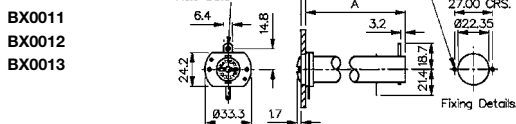
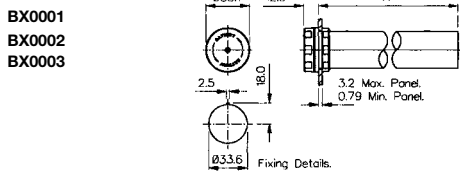

1 pz
1 pc
1 pce

pronta
in stock
en stock



PORTABATTERIE

Battery holders | Porte-piles

Corpo	Body	Corps
Nylon poliestere caricato vetro UL94V-0 Policarbonato (BXS011-12-13)	Nylon glass filled polyester UL94V-0 Polycarbonate (BXS011-12-13)	Nylon polyester chargé verre UL94V-0 Polycarbonate (BXS011-12-13)
Temperatura di lavoro -30°C +70°C	Operating temperature -30°C +70°C	Température de travail -30°C +70°C
Grado di protezione IP67	Sealing IP67	Indice de protection IP67



Codice	Tipo batteria	Dim. batteria	N°poli	Contatti
Code	Battery type	Battery dim.	N°poles	Contacts
Code	Type de pile	Dim. de pile	N°pôles	Contact
BXS001	C (R14)	Ø26,2x50	1	Ottone stagnato - Tappo: argento nichelato
BXS002	C (R14)	Ø26,2x50	2	Brass tin plated - Cap: nickel silver
BXS003	C (R14)	Ø26,2x50	3	Laiton étamé - Capot: argent nickelé
BXS011	AA (R6)	Ø14,5x50,5	1	Posteriori: ottone stagnato - Ant. e tappo: argento nichelato
BXS012	AA (R6)	Ø14,5x50,5	2	Rear: brass tin plated - Front and cap: nickel silver
BXS013	AA (R6)	Ø14,5x50,5	3	Arrière: laiton étamé - Avant et capot: argent nickelé
BXS016	D (R20)	Ø34,2x61,5	1	Ottone nichelato
BXS017	D (R20)	Ø34,2x61,5	2	Nickel plated brass
BXS018	D (R20)	Ø34,2x61,5	3	Laiton nickelé

Dimensioni | Dimensions | Dimensions

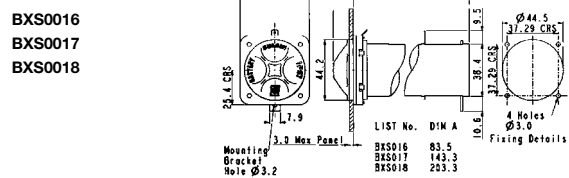
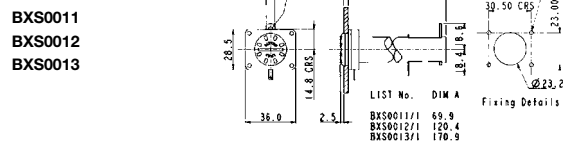
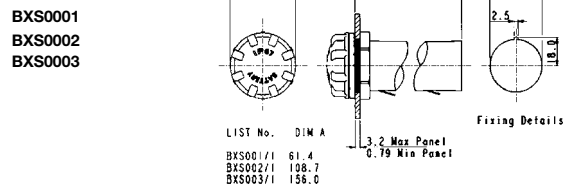

1 pz
1 pc
1 pce

pronta
in stock
en stock