

# **ODOT-PNM02 V2.1**

## **Protocol Converter**

### **User Manual**

V1.8

2022.02.08

## Modbus-RTU/ASCII or Non-standard protocol to ProfiNet Converter



**Odot Automation System Co., Ltd.**

2018-03

Copyright ©2019 Odot Automation all rights reserved

## Version Information

The document has the following modifications:

Date	Version	Modify content	Author
20180301	V1.0	release version	CCL
20180801	V1.1	update content	CCL
20190520	V1.2	Added related descriptions used in Step7	LJP
20190924	V1.3	Freeport mode added	CCL
20191118	V1.4	Added the application of Freeport mode in TIA/STEP7 V5.5/STEP 7-MicroWIN SMART	CCL
20200722	V1.5	Product hardware upgrading, hardware description update.	CCL
20200824	V1.6	The free transparent transmission mode of the master and slave is changed to two independent serial ports	CCL
20220208	V1.7, V1.8	hardware revision	CCL

## **Ownership rights information**

Without the permission of the copyright owner, all or part of this document shall not be republished as a paper or electronic document.

## **Disclaimer**

This document is only intended to assist the reader in using the products, and the company shall not be responsible for any loss or error caused by the use of the information in this document. The product and text described in this document are under constant development and refinement. Odot Automation System Co., Ltd. has the right to modify this document without notifying users.

## **Software download**

Please log on the official website: [www.odotautomation.com](http://www.odotautomation.com) and click on the corresponding product page to download.

## **Revision description:**

1.GSD file 20190312 and above, in gateway slave mode: To avoid the problem of address overlap when customers use Area 0 and Area 4 to output data, pls use Area 1 and Area 3 for PN output data, and Area 0 and

Area 4 for input data.

2. GSD file 20190312 and above versions are applicable to ABB Profinet master system.

3. Firmware V1.6 and above version add function: when the gateway works in transparent transmission mode, When the serial port selects the master-slave response mode, it also supports the active data reporting function.

4. ODOT-PNM02 V2.0 hardware revision, and the two serial ports could independently set working mode, but the converter function does not support IRT and MRP.

**5. ODOT-PNM02 V2.1 supports 200 slots for reading and writing commands.**

**catalog**

ODOT-PNM02 V2.1..... 1

Protocol Converter ..... 1

1.product description. .... 7

    1.1 Product Features ..... 7

    1.2 The main technical parameters ..... 8

2.Hardware description..... 10

    2.1 Appearance ..... 10

    2.2 Indicator LED description..... 11

    2.3 Terminal definition ..... 13

    2.4 External terminal resistance ..... 14

    2.5 Installation size ..... 16

3. Product application ..... 17

    3.1 Converter working mode ..... 17

    3.2 Converter Default Parameters..... 17

    3.3 Converter read and write command module..... 19

    3.4 Converter application topology..... 26

4.Appendix ..... 28

    4.1. Modbus-RTU Introduction to Agreement ..... 28

    4.2 Modbus Storage area..... 28

    4.3 Modbus function code..... 29

5.Brief introduction of serial network topology ..... 37

    5.1 RS232 ..... 37

    5.2 RS422 ..... 39

    5.3 RS485 ..... 42

## 1. product description

### 1.1 Product Features

ODOT-PNM02 V2.1 gateway is a Modbus-RTU/ASCII or non-standard protocol to ProfiNet protocol converter. It can realize the conversion from Modbus-RTU/ASCII or non-standard protocol to ProfiNet. Any device with RS485/RS232/RS422 interface supports Modbus-RTU/ASCII or non-standard protocol can use this product to realize interconnection with industrial bus ProfiNet. Such as: PLC, DCS, remote IO, VFD, scanner, motor start protection device, intelligent high and low voltage electrical appliances, electricity measuring device, intelligent field measuring equipment and instruments, etc.

#### Notice:

The product marked as **ODOT-PNM02**, and the GSD file uses the GSD configuration of **PNM02 V1.5** in GSDML-V2.33-ODOT-PNM02-20191008.xml.

The product marked as **ODOT-PNM02 V2.0** and the GSD file uses the GSD configuration of **PNM02L V2.0** in GSDML-V2.33-ODOT-PNM02-V2.0.

The product marked as **ODOT -PNM02 V2.1**, and the GSD file uses the GSD configuration of **PNM02L V2.1** in GSDML-V2.33-ODOT-PNM02-V2.0.

## 1.2 The main technical parameters

- ◆ Installation method: 35mm standard rail installation
- ◆ dimension: 110\*110\*27.5mm
- ◆ Support standard ProfiNet I/O Device V2.3
- ◆ Profinet data area: The max input is 1440 bytes, and the max output is 1440 bytes.
- ◆ It supports RT (synchronization), does not support IRT (isochronous synchronization), MRP (media redundancy protocol), and MRPD (media path planning redundancy) functions.
- ◆ Supports: 60 slaves (200 read and write commands)
- ◆ Serial port isolation: optocoupler isolation, power isolation
- ◆ Number of serial ports: support dual serial port RS485/RS232/RS422, 2 Serial ports work independently.
- ◆ Serial port terminal resistance: an external 120Ω resistance is required.
- ◆ Serial protocol: Supports Modbus-RTU/ASCII Master, Modbus-RTU/ASCII Slave and free port transparent transmission protocol.
- ◆ Serial port parameters: Support 1200-115200 baud rate, support none, odd, even parity
- ◆ Support Modbus function code: 01/02/03/04/05/06/15/16
- ◆ Power supply: 9-36VDC input, nominal 24VDC



- ◆ Operating temperature: -40~85°C
- ◆ environment humidity: 5%-95%(No condensation)
- ◆ Protection level: IP20

## 2. Hardware description

### 2.1 Appearance



The upper panel has two ProfiNet interfaces and power connection terminals. PORT1 and PORT2, the two interfaces have the same function. These two interfaces have the switch function, that is, the host computer can access the equipment connected to PORT2 through the PORT1 interface, as shown in the figure below (the computer IP is 192.168.1.92, the computer is connected to the PORT2 port, Siemens S7 -1200 connects

to PORT1), the upper computer software can search for devices in the same ProfiNet Network.

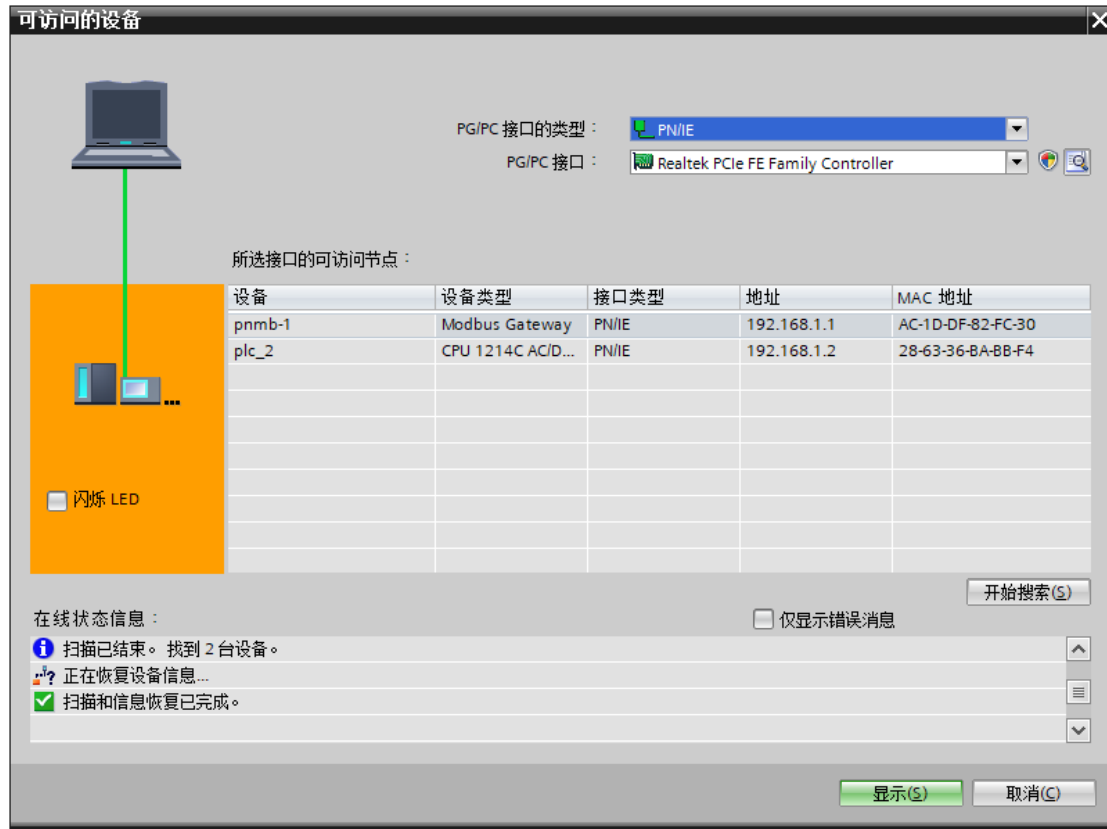

The front panel is a gateway serial port terminal. The serial port terminal is 2 serial ports when used for RS-232 communication or RS-485 communication, and 1 serial port when used for RS-422 communication. For specific definitions, see 2.3 Terminal Definitions.

## 2.2 Indicator LED description

The equipment has 6pcs of LED status indicators, the symbol definition and status description are shown in the table below.

Symbol	Definition	Status	Description
PWR	Power indicator	Red light is on	power supply on
		Red light is off	Power is not connected
DF	Device status indication	Red light is on	Device failure
		Red light is off	Device is normal
SF	System status indication	Red light is on	system error
		Red light flashing	Lighting test
		Red light is off	System is normal
BF	Bus status indication	Red light is on	The network cable is not connected
		Red light flashing	The bus configuration is not configured
		Red light is off	Bus is normal
CO1	Serial port 1 status indication	Green light Flashing	Serial port 1 has data transmission and reception
		Green light is off	Serial port 1 has no data transmission and reception
CO2	Serial port 2 status indication	Green light Flashing	Serial port 2 has data transmission and reception

		Green light is off	Serial port 2 has no data transmission and reception
--	--	--------------------	--

### 2.3 Terminal definition

The equipment wiring adopts 6Pin 3.81mm pitch plug-in terminal. The terminal definition of RS485 interface is shown in the table below.

Serial number	Mark	Wiring definition		
		RS485	RS232	RS422
1	1TA+	Serial port1 (A+)		Serial port1 (TX+)
2	1TB-	Serial port1 (B-)		Serial port1 (TX-)
3	1R+			Serial port1 (RX+)
4	1R-			Serial port1 (RX-)
5	GND	Common ground (signal ground)		
6	1TX		Serial port1 1 (TX)	
7	1RX		Serial port1 1 (RX)	

8	PE	Shield ground		
9	2TA+	Serial port 2 (A+)		Serial port2 (TX+)
10	2TB-	Serial port 2 (B-)		Serial port2 (TX-)
11	2R+			Serial port2 (RX+)
12	2R-			Serial port2 (RX-)
13	GND	Common ground (signal ground)		
14	2TX		Serial port 2 (TX)	
15	2RX		Serial port 2 (RX)	
16	PE	Shield ground		

The definitions of power wiring terminals are shown as below :

No.	Terminals	Definitions
1	PE	Grounding
2	V-	24Vdc-
3	V+	24Vdc+

## 2.4 External terminal resistance

According to the actual situation on site, a 120Ω terminal resistor needs to be connected to the serial port of the gateway. The RS485 bus supports

a maximum of 32 nodes without relays. The nodes are connected by a "daisy chain" connection. Terminal resistors are required at both ends of the communication cable, and the resistance is required to be approximately equal to the characteristics of the transmission cable impedance. In short-distance transmission, termination resistors are not required, that is, termination resistors are generally not required below 300 meters. The terminating resistor is connected to the two ends of the transmission cable. When the gateway is applied in the field, if the field RS485 bus is far away and the field interference is large, it is necessary to add 120Ω terminal resistance at both ends of the RS485 bus to prevent the reflection of the serial signal.

Note: The 120Ω resistor is attached in the box, please check it.

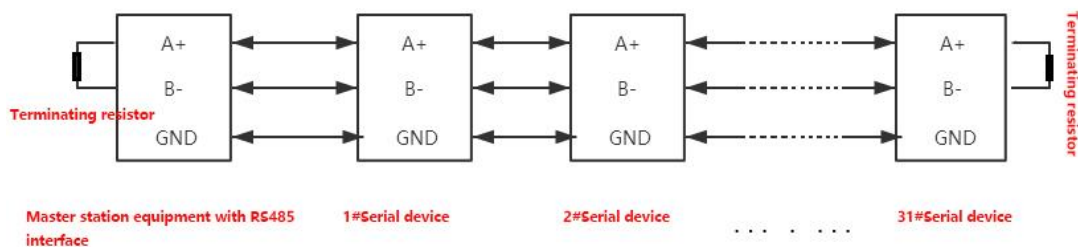

## 2.5 Installation size





### 3. Product application

**The converter ODOT-PNM02 V2.1, it requires to use ODOT IO CONFIG software to configure serial port parameters and read & write commands of slave devices.**

#### 3.1 Converter working mode

**Each serial port of the converter has 3 working modes: Modbus master, Modbus slave, and free port transparent transmission mode.**

When the serial port works in master mode and the serial port can connect up to 31pcs of Modbus RTU/ASCII slave devices. This mode is mainly used for data communication between ProfiNet master and Modbus RTU/ASCII slave.

When the serial port works in slave mode and the serial port can be connected to 1pc of Modbus RTU/ASCII master device. It could realize the data communication between ProfiNet master and Modbus RTU/ASCII master.

If the serial port works in free port transparent transmission mode, and this serial port can be connected to 1pc of serial port device. It could realize the data communication between ProfiNet master and serial port device.

#### 3.2 Converter Default Parameters

##### **ProfiNet configuration parameter:**

Device name: Default: pnmb-address. It needs to change the device name during application. During configuration, please ensure that the configured device name is the same as the actual device name.

##### **Serial port configuration parameters:**

Note: M indicates that the parameter is valid in the master mode, S indicates that the parameter is valid in the slave mode, and F indicates that the parameter is valid in the free port transparent transmission mode.

M/S/F: gateway mode: Modbus master, Modbus slave, and free free port transparent transmission are Optional. The default is Modbus master.

M/S/F: baud rate. It can select standard baud rate or customized baud rate. Default

value: standard baud rate.

M/S/F: standard baud rate. Serial port baud rate, 300-500000bps is optional. The default value is 9600bps.

M/S/F: customized baud rate. 0, 300-500000bps can be set. The default value is 9600bps. **Note: If some customer equipment is with non-standard baud rate, and it can customize the baud rate.**

M/S/F: Data bits: 7 bit and 8 bit are optional. The default value is 8 bit.

M/S/F: parity bit: none, odd, even, character, space is optional. The default is none.

M/S/F: Stop bit: 1 bit, 2 bit. The default is 1 bit.

M/S: Serial mode: RTU/ASCII mode is optional. The default is RTU mode.

M/S/F: character interval: interval for detecting the received message. 1.5t~2000t is optional. The default value is 5t. (T is the transmission time of a single character, which depends on the baud rate).

M/F: Response timeout (ms) : The time that the master waits for the slave to respond after sending a command. 1~65535 is optional. The default value is 500.

M: Polling delay (ms) : interval for sending Modbus commands (delay from receiving a response message to sending the next command). 0~65535 is optional. The default value is 10.

M: error handling method for reading commands: After the slave reading data timeout, the data processing method, hold last input value and clear the input value are optional. Default is hold last input value.

M: Output mode: polling and event-triggered (data changes) are optional. Polling is the default mode. In polling mode, the Modbus periodically sends Write Message. In Event-triggered mode, Write Commands are sent only when the Modbus output data changes.

M: Module control: Disable and enable are optional. The default is disabled. To control the read/write commands of the Modbus, it can select Enable mode and control the read/write commands of the Modbus by controlling the value of Module Control Output.

M: Control mode: level trigger (continuous effective) and rising edge trigger (single trigger) are optional. The default is level trigger (continuous effective). This value is valid only in module control enable mode.

M: first output data after power on (command) : Enable and disable are optional. This default is enabled.

S: Slave ID: 1-247 can be set. This parameter is valid only in slave mode.

S: Response delay (ms) : 0~65535 is optional. The default value is 50.

## 3.3 Converter read and write command module

### 3.3.1 Module in master mode

M: diagnosis module

M: read coil (0xxxx) supports 8 ~ 200bits optional

M: read the discrete input (1xxxx) supports 8 ~ 200bits optional

M: read input register (3xxxx) supports 1~125words optional

M: read hold register (4xxxx) supports 1~125words optional

M: write coil (0xxxx) supports single coil, 8~200bits optional

M: write hold register (4xxxx) supports single register, 1~125words optional

M: Diagnosis module: including module status input, module error code input, module control output, polling time input. The pop-down menu command must be added to the first 8 lines of the slot.

1. Module status input: 8 ~ 48 channels are available. The module status can monitor the working status of each data slot. When a data slot is faulty, the corresponding status bit will be set to 1.

2. Module error code input: 1-48 channels are available. When the data slot is faulty, the error code module can display the function code of the faulty channel and the specific error code. Users can judge the cause of the fault according to the error code, and then take corresponding adjustment methods. For detailed description, please see

"Modbus Error Code Table".

3. Module control output: 8~48 channels are available. When the parameter (M: module control) of the serial port is set to enable mode, the output control read and write channels of this command is effective.

4. Polling time: used to monitor the polling time of the serial port.

M:Modbus slave:

Serial port number: COM1 and COM2 are optional. The default setting is COM1.

Serial port number of the converter to which the slave device is connected.

Private time parameters: Disable and Enable are optional. It is disabled by default.

After this function is enabled, the response timeout time and polling interval time are executed according to the parameters of Modbus slave. After this function is disabled, response timeout time and polling interval time are executed according to the parameters configured in the serial port configuration.

Slave ID: 1-147 is configurable. It is the station address of the slave device.

Response Timeout (ms) : The time that the master waits for the slave to respond after sending a command. 1~65535 is optional. The default value is 1000.

Polling delay time (ms) : interval time for sending Modbus commands (delay between receiving a response message from the slave and sending the next command).

0~65535 is optional. The default value is 100.

### Modbus master mode error code table

Error Code	Fault description	Troubleshooting method
0x00	working properly	None
0x01	illegal function code	The device does not support the current function code. Select the corresponding function code module by referring to the slave manual
0x02	illegal data address	If the device data exceeds its address range, please modify the starting address or data length by referring to the slave manual
0x03	illegal data value	Data length error, the data length exceeds the

		max allowed value 125(Word) or 2000(Bit), please modify the data length
0x04	data processing error	Check if the range of data value meets slave requirements
0x05	the length of the application layer does not match	Increase the received character interval and check the communication parameter settings
0x06	protocol ID error	Check the sender message
0x07	buffer address error	Device internal error
0x08	bit offset error	Device internal error
0x09	The slave ID does not match	Increase the timeout period, check the hardware connection status and the communication parameter settings
0x0A	CRC error	CRC error, check the communication line
0x0B	LRC error	LRC error, check the communication line
0x0C	The response function code does not match	Check the hardware connection status
0x0D	The reply address does not match	Check the hardware connection status
0x0E	The reply data length does not match	Check the hardware connection status
0x0F	Communication timeout	Increase the timeout period, check the hardware connection status and the communication parameter settings
0x10	Error in ASCII mode start character	‘:’ The colon start character error
0x11	ASCII mode ending character error	CR/LF Error at end of carriage return newline
0x12	Non-character data in ASCII mode	The data contains non-hex ASCII code
0x13	ASCII mode character number error	The slave reply length is error

### 3.3.2 Module in slave mode

S : diagnosis module

S: Modbus slave

- S : read coil (0xxxx) supports 1~1024Bytes optional
- S : read hold register (4xxxx) supports 1~512words optional
- S : write coil (0xxxx) supports 1~1024Bytes optional
- S : write the discrete input (1xxxx) supports 8~1024Bytes optional
- S : write input register (3xxxx) supports 1~512words optional
- S : write hold register (4xxxx) supports 1~512words optional
- S : diagnosis module

The slave input status of the module can monitor communication failures. For detailed description, please see "Modbus Error Code Table".

S: Modbus slave

Serial port number: COM1 and COM2 are optional. The default setting is COM1.

Serial port number of the converter to which the slave device is connected.

**Modbus slave mode error code table**

Error Code	Fault description	Troubleshooting method
0x00	working properly	None
0x01	illegal function code	The device does not support the current function code. Select the corresponding function code module by referring to the slave manual
0x02	illegal data address	If the device data exceeds its address range, please modify the starting address or data length by referring to the slave manual
0x03	illegal data value	Data length error, the data length exceeds the max allowed value 125(Word) or 2000(Bit), please modify the data length
0x04	data processing error	Check if the range of data value meets slave requirements
0x05	the length of the application layer does not match	Increase the received character interval and check the communication parameter settings

0x06	protocol ID error	Check the sender message
0x07	buffer address error	Device internal error
0x08	bit offset error	Device internal error
0x09	The slave ID does not match	Increase the timeout period, check the hardware connection status and the communication parameter settings
0x0A	CRC error	CRC error, check the communication line
0x0B	LRC error	LRC error, check the communication line
0x0C	The response function code does not match	Check the hardware connection status
0x0D	The reply address does not match	Check the hardware connection status
0x0E	The reply data length does not match	Check the hardware connection status
0x0F	Communication timeout	Increase the timeout period, check the hardware connection status and the communication parameter settings
0x10	Error in ASCII mode start character	‘:’ The colon start character error
0x11	ASCII mode ending character error	CR/LF Error at end of carriage return newline
0x12	Non-character data in ASCII mode	The data contains non-hex ASCII code
0x13	ASCII mode character number error	The slave reply length is error

### 3.3.3 Module in free port transparent transmission mode

F : Free port - Control and status module

F : The input and output data modules both support 1~512words optional  
 Serial port number: COM1 and COM2 are optional. The default setting is COM1.  
 Serial port number of the converter to which the slave device is connected.  
 Communication mode: active reporting mode, request-reply mode, active reporting mode and request-reply mode.

Process data definition of control and state module:

IO module data direction	Data name	Variable name	Data type	Byte offset
Input data	Output control word - feedback	Control_Word_Feedback	uint16_t	0
	Send frame length - feedback	Send_Data_Len_Feedback	uint16_t	2
	Serial port status	COM_Status	uint16_t	4
	Received error frame count	Error_Counter	uint16_t	6
	Total received data frame count	Received_Counter	uint16_t	8
	The current length of received frames in bytes	Received_Data_Len	uint16_t	10
Output data	Output control word	Control_Word	uint16_t	0
	Sent frame bytes length	Send_Data_Len	uint16_t	2

Variable Definition:

Variable Name	Bit15-6	Bit5	Bit4	Bit3	Bit2	Bit1	Bit0
Control_Word	Reserved	Received Counter Reset	Error Counter Reset	Timeout Error Reset	Parity Error Reset	Done Reset	Trigger
Send_Data_Len	Send_Data_Len						
COM_Status	Reserved			Timeout Error	Parity Error	Done	Busy
Error_Counter	Error_Counter						
Received_Counter	Received_Counter						
Received_Data_Len	Received_Data_Len						

**Input Data Description:**

1. Control\_Word\_Feedback indicates the feedback value of the output control word Control\_Word. After the output control word is refreshed to the module, it will



be updated to the control word feedback.

2. Send\_Data\_Len\_Feedback is the feedback value of Send\_Data\_Len. After the sending frame byte length is refreshed to the module, it will be updated to the sending frame byte length feedback.

3. In answer mode, the Busy bit is set to 1 when the serial port sends data.

3.1 When the serial port receives the answer within the timeout period, the Busy bit is cleared and the Done bit is 1. The Received\_Counter count is increased by 1. If the received frame has a parity error, the Parity\_Error bit is set to 1 and the Error\_Counter count is increased by 1. The number of bytes in Received\_Data\_Len that holds the currently received frame.

3.2 If the serial port does not receive a response within the timeout period, Busy bit is cleared, Done complete bit is set to 1. Meanwhile, Timeout\_Error is set to 1, Error\_Counter error count is increased by 1, and Received\_Data\_Len is cleared.

4. In active reporting mode, the Received\_Counter count is increments by 1 when the packet is received from the slave. If the received frame has a parity error, the Parity\_Error bit is set to 1 and the Error\_Counter count is increased by 1.

#### **Output Data Description:**

1. Received\_Counter\_Reset, when rising edge, the received count value

Received\_Counter is cleared to 0 ;

Error\_Counter\_Reset, rising delay, Error\_Counter is cleared to 0;

Timeout\_Error\_Reset, rising delay, Timeout\_Error is cleared to 0,

Parity\_Error\_Reset, rising delay, Parity\_Error is cleared to 0,

Done\_Reset, Rising delay, Done is cleared to 0.

2. In active reporting mode, the Trigger bit is invalid and Send\_Data\_Len is invalid.

3. In the master/slave response mode, the Trigger ascending delay will trigger the serial port to send data once. The serial port sends data packets according to the data length of Send\_Data\_Len and waits for the response processing.

### 3.4 Converter application topology

Topology diagram of master Mode

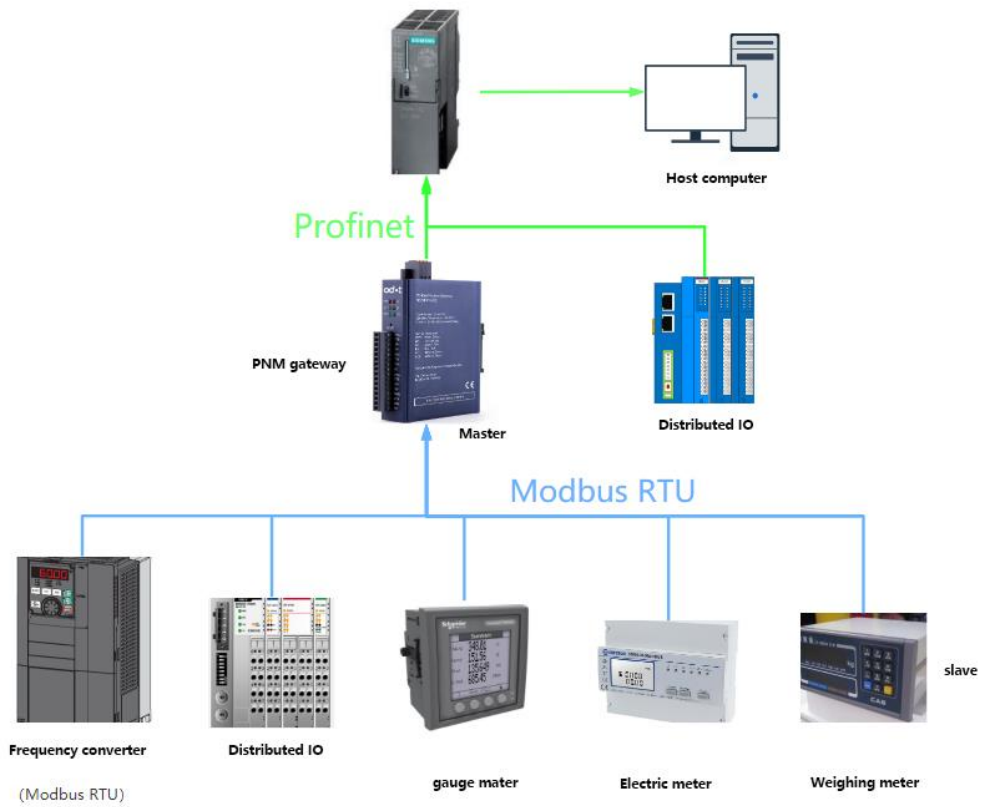

### Topology diagram of slave mode

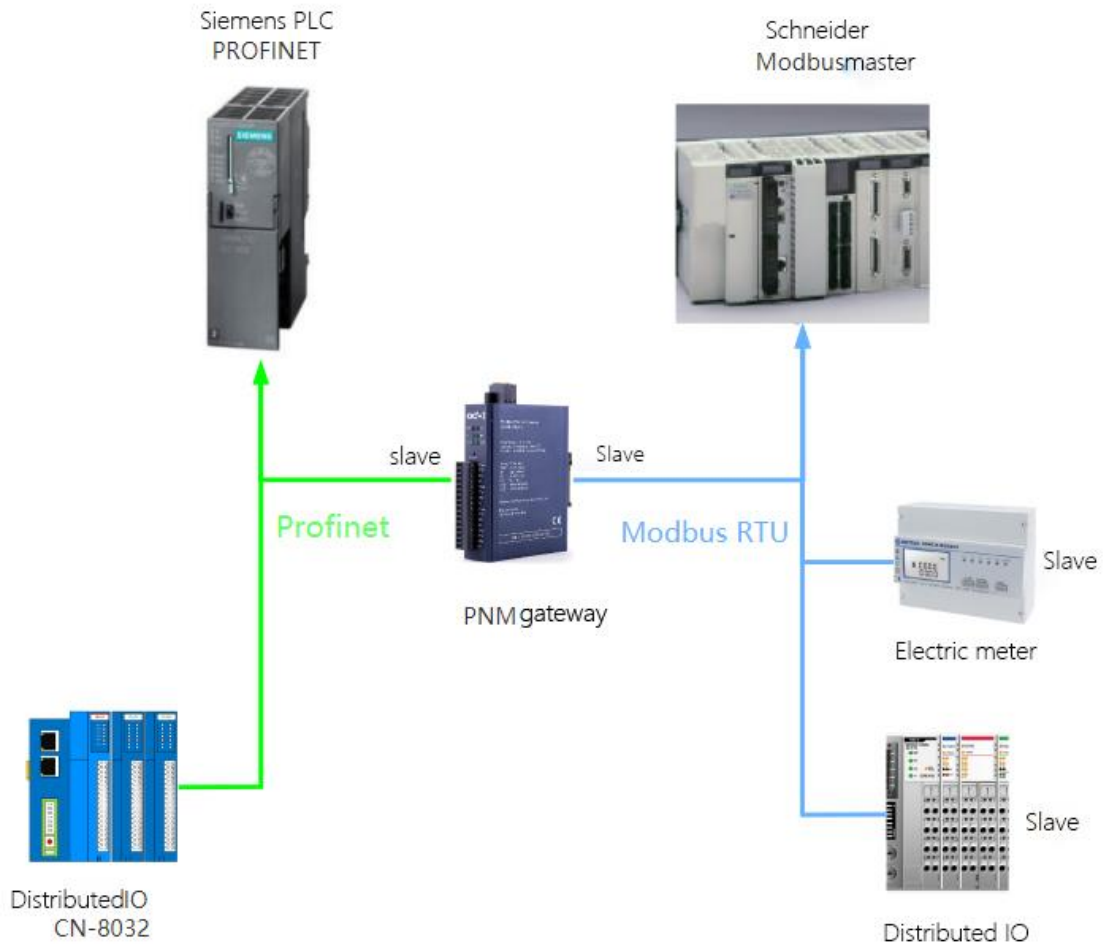

Topology of free port transparent mode



## 4. Appendix

### 4.1. Modbus-RTU Introduction to Agreement

For you, you only need to understand that Modbus has 8 important function codes corresponding to 4 areas: 4 for reading, 2 for writing a single bit or register, and 2 for writing multiple bits or multiple registers. (Address description uses PLC address)

### 4.2 Modbus Storage area

The storage area of the controller (or Modbus device) involved in

Modbus is identified by 0XXXX, 1XXXX, 3XXXX, 4XXXX.

Store ID	Name	type of data	Read/write	Storage unit address
0XXXX	Output coil	Bit	Read/write	00001~0XXXX, XXXX: Related to equipment
1XXXX	Discrete input	Bit	Read only	10001~1XXXX, XXXX: Related to equipment
3XXXX	Input register	word	Read only	30001~3XXXX, XXXX: Related to equipment
4XXXX	Output/holding register	word	Read/write	40001~4XXXX, XXXX: Related to equipment

### 4.3 Modbus function code

The Modbus message is relatively fixed, so you only need to understand it a little bit. After reading a few messages, you will know its structure, and you can inquire about it when you need it.

(1) Read output coil status

Function code: 01H

Master query message format:

address	function code	Start address high	Start address low	High number of coils	Low number of coils	CRC
0x11	0x01	0x00	0x13	0x00	0x25	xxxx

Function: Read the 0XXXX status of the slave output coil.

Note: The start address of the coil of some equipment is 00000, which corresponds to the address 00001 in the equipment, which is sequentially extended.

This example: read the output coil of slave station 0x11, the register start address is 0x13=19, the number of coils is 0x0025H=37; therefore, the function of this query message is: read 0x11(17) slave station output coil 00019—00055, A total of 37 coil states.

Slave response format:

address	function code	Byte count	Coil state 19-26	Coil state 27-34	Coil state 35-42	Coil state 43-50	Coil state 51-55	CRC
0x11	0x01	0x05	0xCD	0x6 B	0xB 2	0x0E	0x1B	xxxx

Function: Slave machine returns to output coil 0XXXX state

(2)Read discrete input state

Function code: 02H

Master inquiry message format:

address	function code	Start address	Start address low	High number of	Low number of coils	CRC
---------	---------------	---------------	-------------------	----------------	---------------------	-----

		high		coils		
0x11	0x02	0x00	0xC4	0x00	0x16	XXXX

Function: Read the status of the slave input coil 1XXXX.

Note: The start address of some equipment coils is 10000, which corresponds to the address 10001 in the equipment, which will be extended sequentially.

This example: read the input coil of slave station 0x11, the starting address is 0x00C4=196, and the number of coils is 0x0016=22.

Therefore, the function of this inquiry message is: read 0x11 (17) slave station input coil 10196-10217, a total of 22 discrete input states.

Slave response format:

address	function code	Byte count	DI 10196-10203	DI 10204-10211	DI 10212-10217	CRC
0x11	0x02	0x03	0xAC	0xDB	0x35	XXX X

Function: Slave machine returns to input coil 1 XXXX state

(3) Read output/holding register

Function code: 03H

Master inquiry message format:

address	function code	Register start address high	Register start address low	High register number	Low register number	CRC
0x11	0x03	0x00	0x6B	0x00	0x03	XXXX

Function: Read the value of the slave holding register 4XXXX.

Note: Some device registers start address 40000 corresponds to 40001 address in the device, and it is postponed sequentially.

This example: read the value of the holding register of the slave station 0x11, the starting address is 0x006BH=107, and the number of registers is 0x0003; therefore, the function of this query message is: reading the 3 holding registers 40107-40109 of the slave No. 0x11 (17H) value

address	function code	byte count	register 40107 high	register 40107 low	register 40108 high	register 40108 low	register 40109 high	register 40109 low	CRC
0x11	0x03	0x06	0x02	0x2B	0x01	0x06	0x2A	0x64	xxxx

Function: The slave returns the value of the holding register:

(40107)=0x022B, (40108)=0x0106, (40109)=0x2A64

(4) Read the input register

Function code: 04H

Master inquiry message format:

address	function code	Register start address high	Register start address low	High register number	Low register number	CRC
0x11	0x04	0x00	0x08	0x00	0x01	xxxx

Function: Read the value of slave station input register 3XXXX.

Note: In some devices, the register start address 30000 corresponds to the address 30001 in the device, and it is extended sequentially.

This example: Reading the value of the input register of slave station 0x11, starting at 0x0008H Note: In some devices, the starting address of



the register 30000 corresponds to the address 30001 in the device, and it is extended sequentially.

This example: read the input register value of slave station 0x11, the starting place is 0x0008H, and the register number is 0x0001;

Therefore, the function of this query message: read the value of 1 input register 30008 of slave station 0x11 (17); the number of registers is 0x0001;

Therefore, the function of this query message: read the value of 1 input register 30008 of slave station 0x11 (17);

Slave response format:

address	function code	Byte count	Input register 30008 high	Input register 30008 low	CRC
0x11	0x04	0x02	0x01	0x01	XXXX

Function: Slave station returns the value of input register 30008;

(30008) = 0x0101

(5) Force a single coil

Function code: 05H

Master inquiry message format:

address	function code	coil address high	coil address low	Disconnect mark	Disconnect mark	CRC
0x11	0x05	0x00	0xAC	0xFF	0x00	XXXX

Function: Force the value of 0x01(17) slave coil 0XXXX. In some devices, the coil start address 00000 corresponds to the address 00001 in

the device, which is sequentially extended.

Disconnect mark=FF00, Set coil ON。

Disconnect mark=0000, Set coil OFF。

Example: The starting address is 0x00AC=172. Force the No. 17 slave coil 0172 to ON.

Response format: original text return

Function: Force No. 17 slave coil 0172 ON to return the original text

address	function code	Coil address high	Coil address low	Disconnect mark	Disconnect mark	CRC
0x11	0x05	0x00	0xAC	0xFF	0x00	xxxx

(6) Preset single holding register

Function code: 06H

Master inquiry message format:

address	function code	coil address high	Register start address low	register number high	register number low	CRC
0x11	0x06	0x00	0x87	0x03	0x9E	xxxx

Function: Preset order to hold the value of register 4XXXX. In some devices, the coil start address of 40000 corresponds to the address of 40001 in the device, which is sequentially extended.

Example: preset the single holding register 40135 of No. 17 slave to 0x039E;

Response format: original text return

address	function code	coil address high	register start address low	register number high	register number low	CRC
0x11	0x06	0x00	0x87	0x03	0x9E	xxxx

Function: Preset No. 17 slave single holding register 40135 as 0x039E

and return to the original text.

(7) Forced multiple coils

Function code: 0FH

Master inquiry message format:

address	function code	coil start address high	coil start address low	number of coils high	number of coils low	Byte count	Coil state 20-27	Coil state 28-29	CRC
0x11	0x0F	0x00	0x13	0x00	0x0A	0x02	0xC D	0x00	xxxx

Function: Force multiple continuous coils 0XXXX to ON/OFF state.

Note: In some devices, the coil start address 00000 corresponds to the address 00001 in the device, which is sequentially extended.

In this example: force multiple continuous coils from the slave station of No. 0x11, the start address of the coil is 0x0013=19, and the number of coils is 0x000A=10

Therefore, the function of this query message is: force the value of 0x11(17) slave station 10 coils 00019-00028; CDH→00019-00026; 00H→00027-00028;

Slave response format:

address	function code	High bit of coil start address	Low bit of coil start address	High number of coils	Low number of coils	CRC
0x11	0x0F	0x00	0x13	0x00	0x0A	XXXX

(8) Preset multiple registers

Function code: 10H

Master inquiry message format:

address	function code	Start register address high	Start register address low	register number high	register number low	Byte count	Data high	Low-level data	Data high	Data low	CRC
0x11	0x10	0x00	0x87	0x00	0x02	0x04	0x01	0x05	0x0A	0x10	XX XX

Function: preset multiple holding register values 4XXXXX of the slave.

Note: In some devices, the starting address of the holding register 40000 corresponds to the address 40001 in the device, which is extended in turn.

This example: preset multiple holding register values of slave station 0x11, the starting address of the register is 0x0087=135, and the number of coils is 0x0002=2.

Therefore, the function of this query message is: preset the values of 2 holding registers of the slave station of No. 0x11 (17); 0105H→40135; 0A10H→40136.

Response format:

address	function code	Start register address high	Start register address Low	register number high	register number Low	CRC
0x11	0x10	0x00	0x87	0x00	0x02	xxxx

## 5. Brief introduction of serial network topology

### 5.1 RS232

RS232 is one of the serial communication interfaces of industrial control, and it is widely used to connect computer serial interfaces and peripherals.

RS232 uses a signal line and a signal return line to form a common ground transmission form. The three-wire connection method can realize full-duplex communication. The transmission signal is a single-ended signal. This common ground transmission is prone to common mode interference. Therefore, the anti-noise interference is weak and the transmission distance is limited. The RS232 interface standard stipulates that the maximum transmission distance standard value is 50 feet

(approximately 15 meters) when the symbol distortion is less than 4%.  
 (Long-distance communication above 15m needs to be adopted Modem),  
 the maximum transmission distance is also related to the communication  
 baud rate. In actual use, if the transmission distance is far, please lower  
 the baud rate. In order to reduce the external electromagnetic interference  
 during signal transmission, please use shielded cables as communication  
 cables.

The RS232 interface standard stipulates on TXD and RXD:

RS232 uses negative logic to transmit signals, and takes  $-(3\sim 15)V$  signal  
 as logic "1"; takes  $+(3\sim 15)V$  signal as logic "0"; voltage between  $-3\sim +3V$   
 It is meaningless, and a voltage lower than  $-15V$  or higher than  $+15V$  is  
 also meaningless.

RS232 interface classification:

DB9 male connector



The upper left corner is 1, the lower right corner is 9

9-pin RS232 serial port (DB9)		
PIN	Name	Effect
1	CD	Carrier detect
2	RXD	Receive data

3	TXD	Receive data
4	DTR	Data terminal is ready
5	GND	Signal ground
6	DSR	Data ready
7	RTS	Request to send
8	CTS	Clear to send
9	RI	Ring alert

Because the RS232 interface has the above-mentioned electrical characteristics, it can only realize point-to-point communication.

The RS232 communication wiring diagram is shown in the figure:

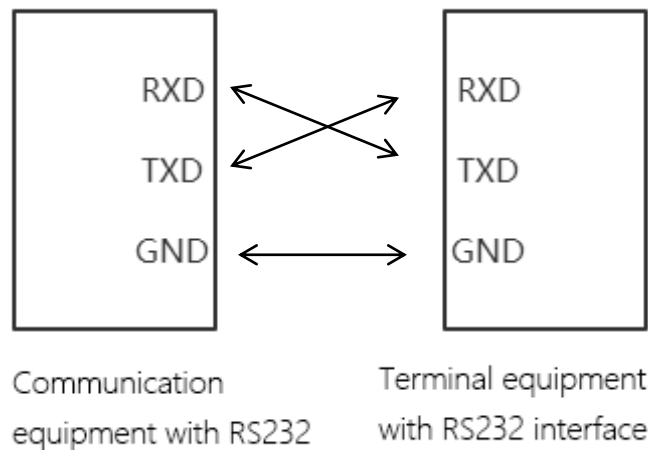

## 5.2 RS422

The full name of RS422 interface standard is "Electrical Characteristics of Balanced Voltage Digital Interface Circuit", which defines the

characteristics of the interface circuit. RS422 adopts four-wire plus ground wire (T+, T-, R+, R-, GND), full-duplex, differential transmission, multi-point communication data transmission protocol. It adopts balanced transmission and adopts unidirectional/non-reversible transmission line with or without enabling end. Because the receiver adopts high input impedance and the transmission driver has stronger driving ability than RS232, it is allowed to connect multiple receiving nodes on the same transmission line, up to 10 nodes can be connected. That is, a master device (Master), and the rest are slave devices (Slave). The slave devices cannot communicate, so RS-422 supports point-to-many two-way communication.

The maximum transmission distance of RS-422 is 4000 feet (about 1219 meters), and the maximum transmission rate is 10Mb/s. The length of the balanced twisted pair is inversely proportional to the transmission rate, and the maximum transmission distance is only possible when the rate is below 100kb/s. Only in a short distance can the highest transmission rate be obtained. Generally, the maximum transmission rate that can be obtained on a 100-meter-long twisted pair cable is only 1Mb/s.

RS-422 needs to be connected to a terminal resistor, and its resistance is required to be approximately equal to the characteristic impedance of the transmission cable. In short-distance transmission, no terminating resistor is needed, that is, no terminating resistor is generally required below 300



meters. The terminating resistor is connected to the far end of the transmission cable.

In the one-master-multi-slave network connection, the sending ends of all slave stations are connected to the receiving end of the last connected to the master station through a daisy chain; the receiving ends of all slaves are connected to the last connected to the master station through a daisy chain. Sender.

RS422 pin definition:

RS422 (9Pin)		effect	Remarks
3	R-	Receiving negative	Must connect
2	T-	Send negative	Must connect
7	R+	Receiving positive	Must connect
8	T+	Send positive	Must connect



The upper left corner is 1, the lower right corner is 9

The RS422 communication wiring diagram is shown in the figure:

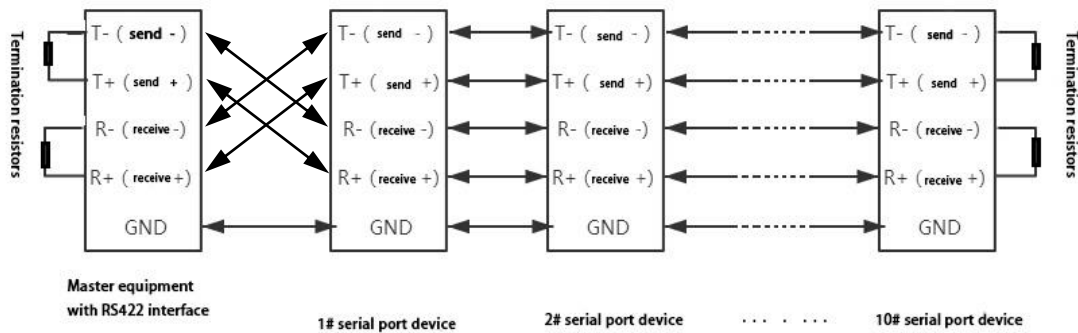

### 5.3 RS485

Since RS-485 is developed on the basis of RS-422, many electrical regulations of RS-485 are similar to RS-422. For example, balanced transmission methods are adopted, and terminating resistors are required to be connected to the transmission line. RS-485 can adopt two-wire and four-wire methods, and the two-wire system can realize true multi-point two-way communication.

RS485 is a standard that defines the electrical characteristics of drivers and receivers in a balanced digital multipoint system. It uses a combination of balanced drivers and differential receivers to enhance the ability to resist common mode interference, that is, to resist noise interference. Since the half-duplex network composed of RS485 interface generally adopts two-wire connection mode, and uses differential signals to transmit data, the voltage difference between the two wires is  $-(2\sim 6)V$ , which means logic "0", the voltage difference between the two wires  $+(2\sim 6)V$  means logic "1".

The RS485 signal transmission distance is related to the communication baud rate. The higher the baud rate, the shorter the transmission distance. When the baud rate is not higher than 100Kbps, the theoretical maximum communication distance is about 1200 meters. In actual use, due to factors such as electromagnetic interference often fail to reach the maximum communication distance. If you are communicating over a longer distance, please lower the baud rate. To reduce the signal's electromagnetic interference during transmission, please use twisted-pair shielded cables as communication cables.

The RS485 bus supports a maximum of 32 nodes without relays. The nodes are connected by a "daisy chain" connection. Terminal resistors are required at both ends of the communication cable, and the resistance is required to be approximately equal to the characteristics of the transmission cable impedance. In short-distance transmission, no terminating resistor is needed, that is, no terminating resistor is generally required below 300 meters. The terminating resistor is connected to the two ends of the transmission cable.

RS485 9-pin pin definition:

Pin	Name	Effect	Note
1	Data-/B-/485-	Send positive	Must connect
2	Data+/A+/485 +	Receivin g positive	Must connect
5	GND	Ground wire	

The RS485 communication wiring diagram is shown in the

figure:

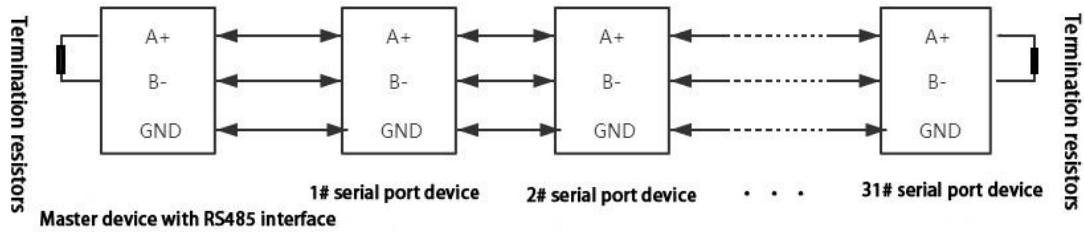

---

## Odot Automation System Co., Ltd.

Add: No.6 Hongsheng Road, Hi-Tech District, Mianyang, Sichuan,China.



Tel: +86-0816-2538289

Zip Code: 621000

Email:sales@odotautomation.com

Web: www.odotautomation.com