

60mm sq.

San Ace 60



General Specifications

- Material Frame: Plastics (Flammability: UL94V-0),
Impeller: Plastics (Flammability: UL94V-1)
- Expected Life Refer to specifications (L10:Survival rate:90% at 60°C ,
rated voltage, and continuously run in a free air state)
- Lead Wire ⊕red ⊖black or blue (Sensor) yellow
- Storage Temperature -30°C to +70°C (Non-condensing)

60×60×15mm (Mass : 60g) **9P**type

Specifications

The following nos. **have pulse sensors and ribs.**

Model No.	Rated Voltage [V]	Operating Voltage Range [V]	Rated Current [A]	Rated Input [W]	Rated Speed [min ⁻¹]	Max. Airflow [m ³ /min] [CFM]	Max. Static Pressure [Pa] [inchH ₂ O]	SPL [dB(A)]	Operating Temperature [°C]	Expected Life [h]
109P0605H701	5	4.5 to 5.5	0.26	1.30	4,100	0.40 14.1	38.2 0.153	32	-20 to +70	60,000/60°C
109P0605M701			0.15	0.75	3,100	0.30 10.6	22.6 0.091	25		
109P0612K701	12	10.2 to 13.8	0.26	3.12	6,500	0.62 21.9	99.3 0.399	45	-20 to +60	40,000/60°C
109P0612S701			0.15	1.80	5,000	0.48 17.0	58.8 0.236	36		
109P0612H701		7 to 13.8	0.09	1.08	4,100	0.40 14.1	38.2 0.153	32		
109P0612M701			0.07	0.84	3,100	0.30 10.6	22.6 0.091	25		
109P0612B701	24	10.2 to 13.8	0.05	0.6	2,200	0.21 7.42	11.7 0.047	21	-20 to +70	60,000/60°C
109P0624J701			14 to 27.6	0.14	3.36	6,200	0.61 21.5	86.5 0.347		
109P0624S701		0.08		1.92	5,000	0.48 16.9	58.8 0.236	36		
109P0624H701		0.06		1.44	4,100	0.40 14.1	38.2 0.153	32		
109P0624M701		20.4 to 27.6	0.04	0.96	3,100	0.30 10.6	22.6 0.091	25		

Models without sensors or with lock sensors are available as options. Please refer to the index (p. 467).

Dimensions (unit: mm)

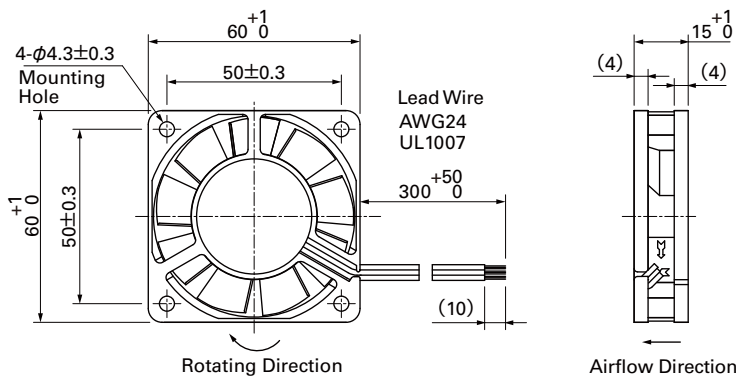

Reference Dimensions of Mounting Holes and Vent opening (unit: mm)

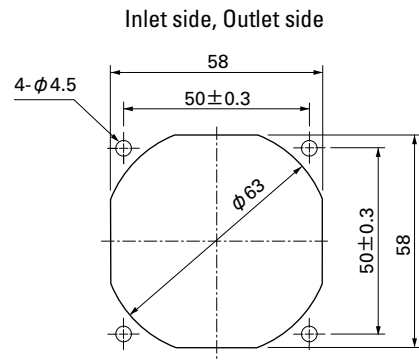

Options (unit: mm)

Finger Guards

Model : 109-139E Surface treatment : Nickel-chrome plating (silver)
: 109-139H : Cation electropainting (black)

Inlet side, Outlet side

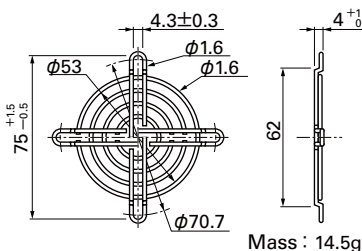

Resin Finger Guards

Model : 109-1003G

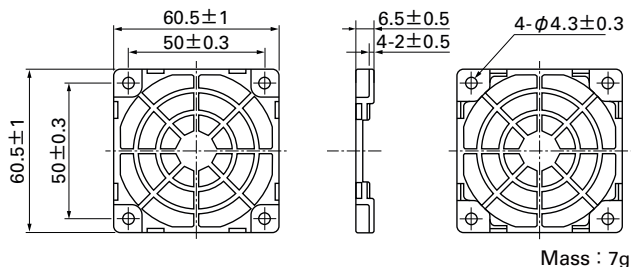

Resin Filter Kits

Model : 109-1003F13 (13PPI), 109-1003F20 (20PPI)
 : 109-1003F30 (30PPI), 109-1003F40 (40PPI)

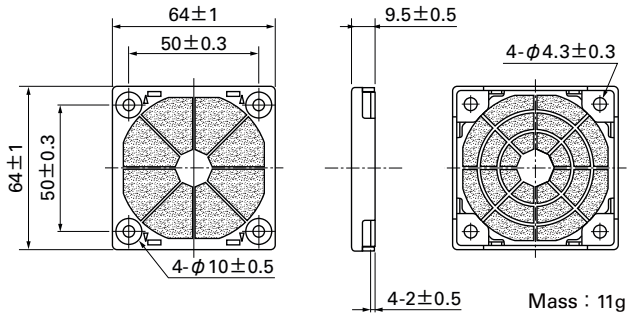

Airflow - Static Pressure Characteristics

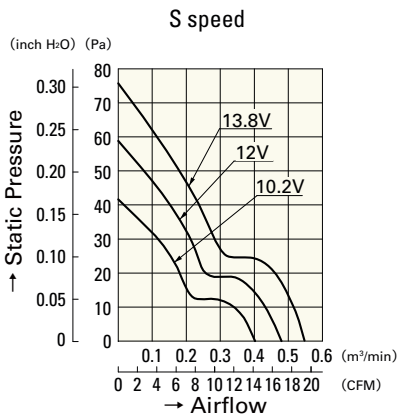

109P0612S701

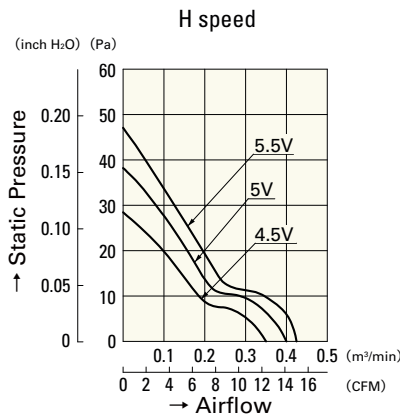

109P0605H701

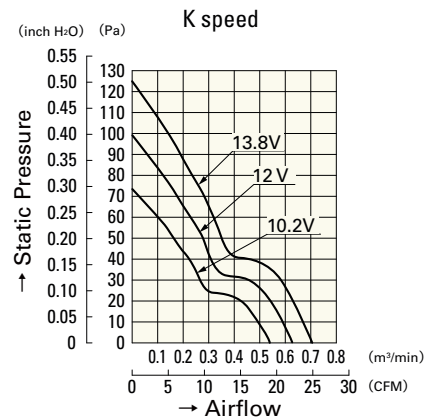

109P0612K701

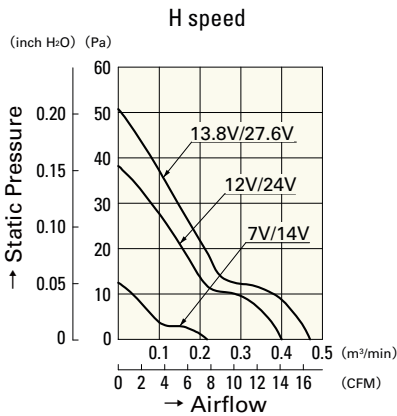

109P0612H701
109P0624H701

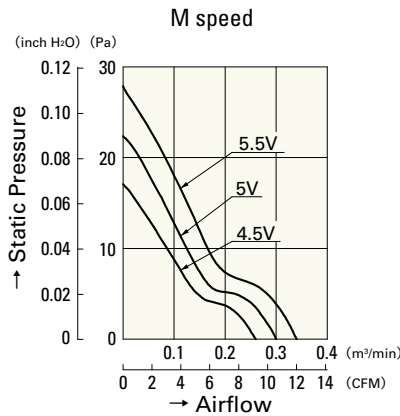

109P0605M701

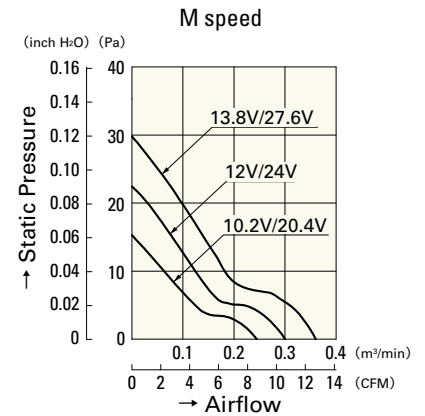

109P0612M701
109P0624M701

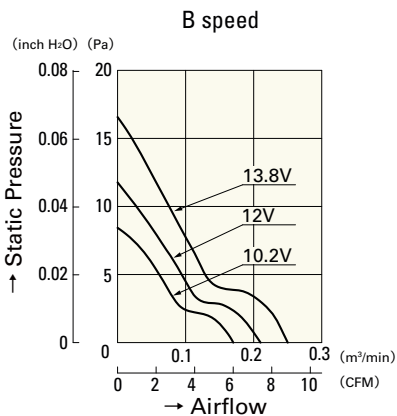

109P0612B701

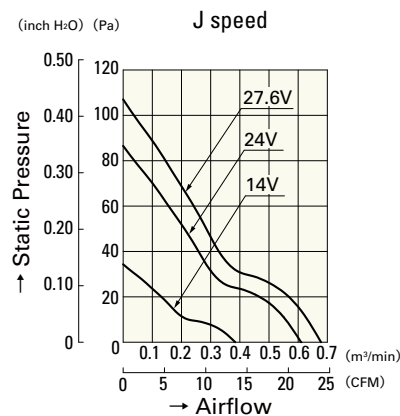

109P0624J701

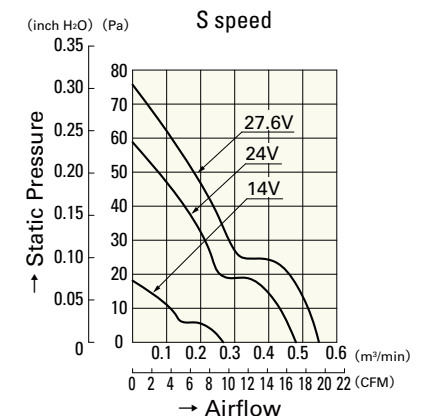

109P0624S701