

Products /  **CASTALDI** / BOX D58 / D58 BOX/P2 / D58/P2-84-MB-AL

BOX D58 D58/P2-84-MB-AL

TECHNICAL DATA

GENERAL



Item code	D58/P2-84-MB-AL
Place installation	outdoor
Name	D58 BOX/P2 / D58/P2-84-MB-AL pole mounted, spot lights, ground mounted
Note	DALI version on request.
Standard colour	AL - aluminium grey (similar to RAL 7040)
Variant colour	GR - graphite satin finish (similar to RAL 7022)
Environments	urban landscape, façades and architectural works, wellness, hallway, art and culture, retail areas, places of worship, residential lighting



PHYSICAL

Installation type	pole mounted, spot lights, ground mounted
Mounting type	pole, ground surface, surface
Painting	Polyester powder coating, with a pluri-processed against corrosion (passed the exposure of over 1500 hours in a saline mist environment).
Screws	AISI 304 stainless steel screws.
Seals	Silicone Rubber.
Body	Corrosion resistant die-cast aluminium body. Aluminium mounting bracket.

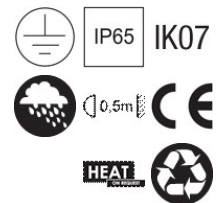

DIMENSIONS

A: Total width device (mm)	207
L: Total length device (mm)	207
Weight (kg)	5,3
Volume piece packed (m3)	0,014

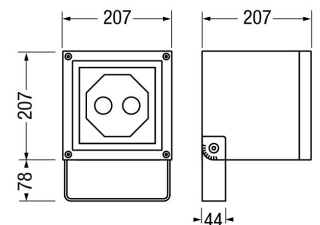

OPTICAL SYSTEMS

Opening beam	medium
Optical System	PC with aluminium coating reflector.
Diffuser	Tempered safety glass - 10 mm thickness, mechanical and thermal shock resistant.

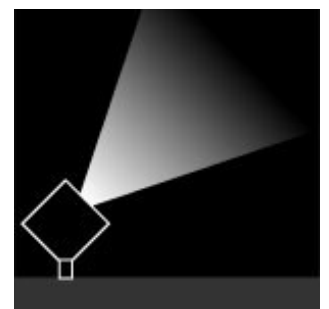

ENERGY SAVING

This luminaire contains built-in LED lamps
The lamps cannot be changed in the luminaire



SOURCES

Source Type	Source Power	System Power	Source	Lamp Socket	Sources Temperature Colour	Nominal Flux	Output Flux	MacAdam
LED COB	-	24W	-	-	4000K CRI>80	-	2320 lm	Step 2

ELECTRICAL

Ballast type	ON-OFF.
Mounting ballast type	Integral
Lifetime	60.000h L90B10 (Ta=25°C)
Line input	Use only (EN 60598-1) cable type H07RN-F with diameter between 7 and 10mm.
Voltage	220-240V
Frequency	50-60Hz
Wiring	Built-in control-gear 220/240V-AC 50/60Hz.

PHOTOMETRICS

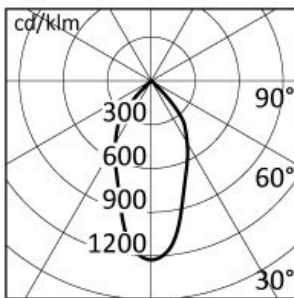

h (m)	Ø (m)	γ=0.0 α=β=47°	Emed (lx)
4.00	3.49		95
8.00	6.97		24
12.00	10.46		11
16.00	13.94		6
20.00	17.43		4

NORMS / DIRECTIVES

Norms	EN 60598-1, EN 60598-2-5
Directives	2014/35/UE, 2014/30/UE

ACCESSORIES

OPTIONAL ACCESSORIES

Mounting

Accessory code	ACS/GA1-AL
Technical description	Universal pole connection. Suitable for one or two fixtures on conical or cylindrical poles with diameters between 65 and 80mm. Powder painting after passivation -AL ALUMINIUM. AISI 304 stainless steel hardware.
A: Total width device (mm)	122
H: Total height device (mm)	131
Weight (kg)	12
Volume of package (m3)	3
Body	Corrosion resistant die-cast aluminium.

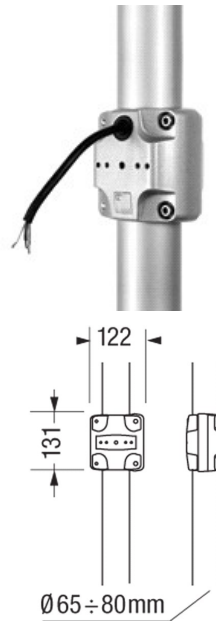

Accessory code	ACS/TP60-AL
Technical description	For models: D30 boxer, D58 box/P1/P2 and D55 flat/P1/P2. Single connection for Ø60mm pole top entry. The single pole connection, suitable for pole top entry or piece of pole Ø60mm, allows to freely adjust the floodlight. Powder painting after passivation -AL ALUMINIUM. AISI 304 stainless steel hardware.
Wind exposed surface (m²)	0,07
Weight (kg)	0,7
Volume of package (m3)	0,003
Body	Corrosion resistant die-cast aluminium body.

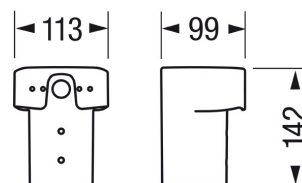

Accessory code	D30T/PZ
Technical description	For models: D30R miniboxer, D30T boxer/T, D58 box/P1/P2, D30 boxer and D55 flat/P1/P2. Ground fixing spike. AISI 304 stainless steel ground spike, fork shaped, that allows the ground mounting of the floodlight.
H: Total height device (mm)	200



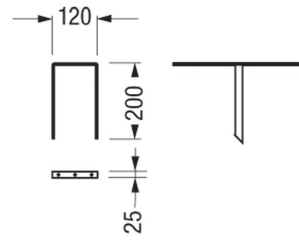

Accessory code ACS/LASER

Technical description Laser pointer.

Accessory code ACS/GA60-AL

Technical description Universal pole connection. Suitable for one or two fixtures on conical or cylindrical poles with diameters between 60 and 63mm. Powder painting after passivation -AL ALUMINIUM. AISI 304 stainless steel hardware.

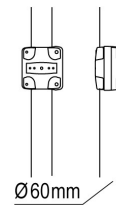

Optical

Accessory code D58/2-VS-GR

Technical description Visor for BOX/C2 and P2 -GR GRAPHITE.



Accessory code D58/2-GP-GR

Technical description Anti-glare louver for BOX/C2 and P2 -GR GRAPHITE.

Accessory code	D58/2-HL
----------------	----------

Technical description	Honeycomb anti-glare louver for BOX/C2 and P2.
-----------------------	--

Accessory code	D58/P2-GP
----------------	-----------

Technical description	For models D58 box/P2/C2. Anti-glare louver.
-----------------------	--



Accessory code	D58/P2-LD
----------------	-----------

Technical description	For models D58 box/P2/C2. Diffused beam lens.
-----------------------	---



Accessory code	D58/P2-LE
----------------	-----------

Technical description	For models D58 box/P2/C2. Elliptical beam lens.
-----------------------	---

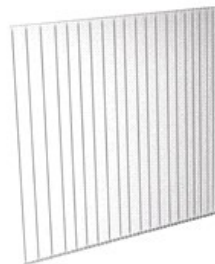

Pole

Accessory code	D22/PT75-AL
----------------	-------------

Technical description	Low poles in aluminium Ø60mm -AL ALUMINIUM, length pole 75cm, for embedded mounting and with the independent base D22/BS to be fixed to flooring and paving.
-----------------------	--

H: Total height device (mm)	750
-----------------------------	-----

Body	Painted -AL ALUMINIUM.
------	------------------------

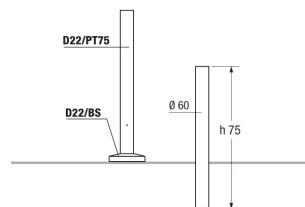

Accessory code	D22/PT105-AL
Technical description	Low poles in aluminium Ø60mm -AL ALUMINIUM, length pole 105cm, for embedded mounting and with the independent base D22/BS to be fixed to flooring and paving.
H: Total height device (mm)	1050
Body	Painted -AL ALUMINIUM.

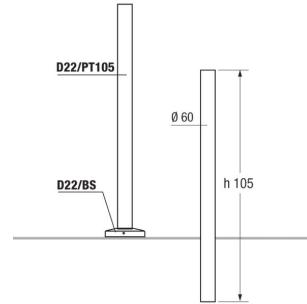

Accessory code	D22/PT250-AL
Technical description	Low poles in aluminium Ø60mm -AL ALUMINIUM, length pole 250cm, for embedded mounting.
H: Total height device (mm)	2500
Body	Painted -AL ALUMINIUM.

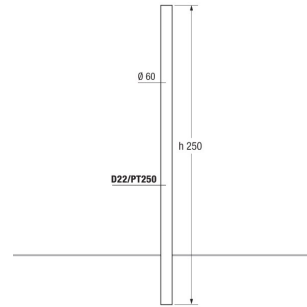

Accessory code	D43/P300-AL
Technical description	Extruded anodized aluminum pole Ø60mm, height above ground level 3m - AL ALUMINIUM.

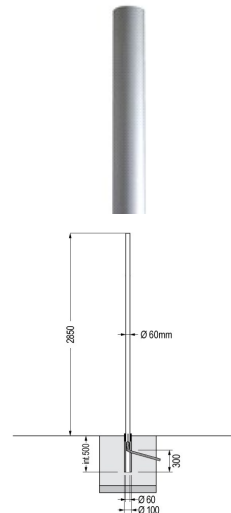

Accessory code	8PTA40608931V-GR
Technical description	Cylindrical straight pole with tang Ø60mm, height above ground level 4m. Complete with shunt terminal block, inspection door and top cap. Hot zinc coated and painted. -GR GRAPHITE.

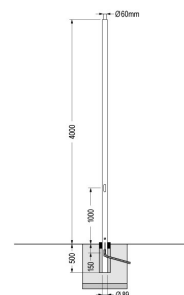

Accessory code 8PRA50608931V-GR

Technical description

Tapered straight pole Ø60mm, height above ground level 5m. Complete with shunt terminal block, inspection door and top cap. Hot zinc coated and painted.
-GR GRAPHITE.

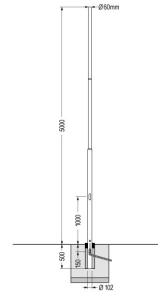

Accessory code 8PRA7060C731V-GR

Technical description

Tapered straight pole Ø60mm, height above ground level 7m. Complete with shunt terminal block, inspection door and top cap. Hot zinc coated and painted.
-GR GRAPHITE.

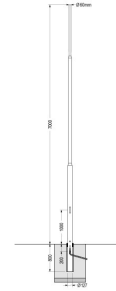

Accessory code 8PCA4060A531V-GR

Technical description

Conical straight pole Ø60mm, height above ground level 4m. Complete with shunt terminal block, inspection door and top cap. Hot zinc coated and painted.
-GR GRAPHITE.

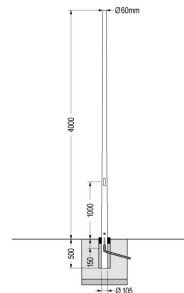

Accessory code 8PCA6060C831V-GR

Technical description

Conical straight pole Ø60mm, height above ground level 6m. Complete with shunt terminal block, inspection door and top cap. Hot zinc coated and painted.
-GR GRAPHITE.



Accessory code 8PCA8060E831V-GR

Technical description

Conical straight pole Ø60mm, height above ground level 8m. Complete with shunt terminal block, inspection door and top cap. Hot zinc coated and painted.
-GR GRAPHITE.

